

# GV6-240 series

240W Waterproof Constant Voltage LED Driver



## Features:

- European AC input voltage: 176-264VAC
- Constant voltage design
- Built-in active PFC function (PF > 0.97)
- Protections: Short Circuit / Over Current / Over Temperature / Input Under Voltage
- Cooling by free air convection
- Surge immunity: Differential Mode - 6kV, Common Mode - 10kV
- IP67 design for indoor and outdoor applications
- Suitable for dry/damp/wet locations

Application:

- Landscape Lighting



## DESCRIPTION

The GV6-240 series is constant voltage led driver, designed for lighting used for landscape illumination. The driver has built-in active PFC, multiple protections, and 10KV surge immunity. It's an excellent design with high reliability and long lifetime.

## MODEL INFORMATION

MODEL NUMBER	OUTPUT POWER [W]	OUTPUT VOLTAGE [VDC]	OUTPUT CURRENT RANGE [A]	TYPICAL EFFICIENCY	TYPICAL PF	TYPICAL THD
GV6-240B024	240	24	0 ÷ 10.0	93%	0.98	5%
GV6-240B036	240	36	0 ÷ 6.7	94%	0.98	5%

### Notes:

1. All performance parameters are measured at 25°C ambient temperature, 230VAC input, full load conditions if no specific note.

## INPUT SPECIFICATIONS

Parameter	Min.		Typ.		Max.		Notes		
INPUT VOLTAGE	176VAC		200 ÷ 240VAC		264VAC		-		
INPUT FREQUENCY	47Hz		50/60Hz		63Hz		-		
LEAKAGE CURRENT	-		-		0.7mA		240VAC/60Hz		
INPUT AC CURRENT	-		-		1.3A		220-240VAC, full load		
INRUSH CURRENT	-		-		75A		230VAC, full load, Cold start		
POWER FACTOR	0.97		0.99		-		230VAC, 50-60Hz, full load		
	0.95		0.97		-		230VAC, 50-60Hz, 75% load		
	0.92		0.95		-		230VAC, 50-60Hz, 50% load		
THD	-		5%		10%		220-240VAC, 50-60Hz, 50-100% load		
MAX. NO. OF PSU ON CIRCUIT BREAKER	B10	C10	B16	C16	B20	C20	B25	C25	230VAC
	2	4	4	6	5	8	6	10	

# GV6-240 series

240W Waterproof Constant Voltage LED Driver



## OUTPUT SPECIFICATIONS

Parameter	Min.	Typ.	Max.	Notes
OUTPUT VOLTAGE TOLERANCE	-2%	-	+2%	-
TOTAL OUTPUT CURRENT RIPPLE (PK-PK)	-2%	-	+2%	Full load, measured by 20MHz bandwidth oscilloscope and the output paralleled a 0.1µF ceramic capacitor and 47µF electrolytic capacitor
TURN-ON VOLTAGE OVERTHOOT	-5%	-	+5%	220-240VAC, full load
LINE REGULATION	-0.5%	-	+0.5%	25°C ± 10°C ambient temperature, input voltage changes from 200VAC to 240VAC
LOAD REGULATION	-1%	-	+1%	25°C ± 10°C ambient temperature, 230 VAC input, load changes from 50% to 100%
TURN-ON DELAY TIME	-	-	0.5s	230VAC, full load

## GENERAL SPECIFICATIONS

Parameter	Min.	Typ.	Max.	Notes
<b>EFFICIENCY AT 230VAC</b>				
GV6-240B024	91%	93%	-	25°C ambient temperature, full load / 75% load / 50% load
GV6-240B036	91%	94%	-	
<b>DIELECTRIC STRENGTH</b>	INPUT-OUTPUT	-	3750VAC	-
	INPUT-PE	-	1875VAC	-
	OUTPUT-PE	-	500VAC	-
<b>GROUNDING RESISTANCE</b>	-	-	0.1Ω	25A/60s, 25°C ± 10°C ambient temperature
<b>INSULATION RESISTANCE</b>	10MΩ	-	-	Input-Output, Input-PE, Output-PE, 500VDC/60s/25°C/70%RH
<b>MTBF</b>	-	200 000 hours	-	25°C ± 10°C ambient temperature, 230VAC, 80% load (MIL-HDBK-217F)
<b>LIFETIME</b>	-	50 000 hours	-	230VAC, 100% load, tc=75°C (refer to Lifetime Curve)
<b>OPERATING CASE TEMPERATURE FOR SAFETY T<sub>C-S</sub></b>	-40°C	-	+90°C	-
<b>OPERATING CASE TEMPERATURE FOR SAFETY T<sub>C-W</sub></b>	-40°C	-	+75°C	5 years warranty, humidity 10% to 100% RH
<b>STORAGE TEMPERATURE</b>	-40°C	-	+90°C	Humidity 10% to 100% RH
<b>DIMENSIONS (L x W x H)</b>	193.5 x 67.2 x 37mm			-
<b>NET WEIGHT</b>	800 ± 100g			-
<b>PACKAGE (L x W x H)</b>	15pcs./box; 502 x 372 x 222 mm			-

# GV6-240 series

240W Waterproof Constant Voltage LED Driver



## SAFETY STANDARDS

SAFETY CATEGORY	COUNTRY / TERRITORY	STANDARDS
CE	Europe	EN61347-1
		EN61347-2-13

## EMC STANDARDS

EMC CATEGORY	COUNTRY / TERRITORY	STANDARDS
CE	Europe	EN55015
		EN61000-3-2
		EN61000-3-3
		EN61547

**Note:** This LED driver meets the EMC specifications above, but EMC performance of luminaire that contains it depends also on the other devices connected to the driver and on the fixture itself.

## PROTECTIONS

PARAMETER	Min.	Typ.	Max.	NOTES
INPUT UNDER VOLTAGE PROTECTION	156VAC	-	176VAC	Turn off the output when the input voltage falls below protection voltage.
OVER TEMPERATURE PROTECTION	Turn off the output. Returning to normal after over temperature is removed.			
SHORT CIRCUIT PROTECTION	Hiccup mode. The output shall return to normal when the fault condition is removed.			
OVER CURRENT PROTECTION	Hiccup mode. The output shall return to normal when the fault condition is removed.			
OVER VOLTAGE PROTECTION	Turn off the output voltage, when the fault is removed, restart and resume.			

# GV6-240 series

240W Waterproof Constant Voltage LED Driver



## MECHANICAL SPECIFICATION

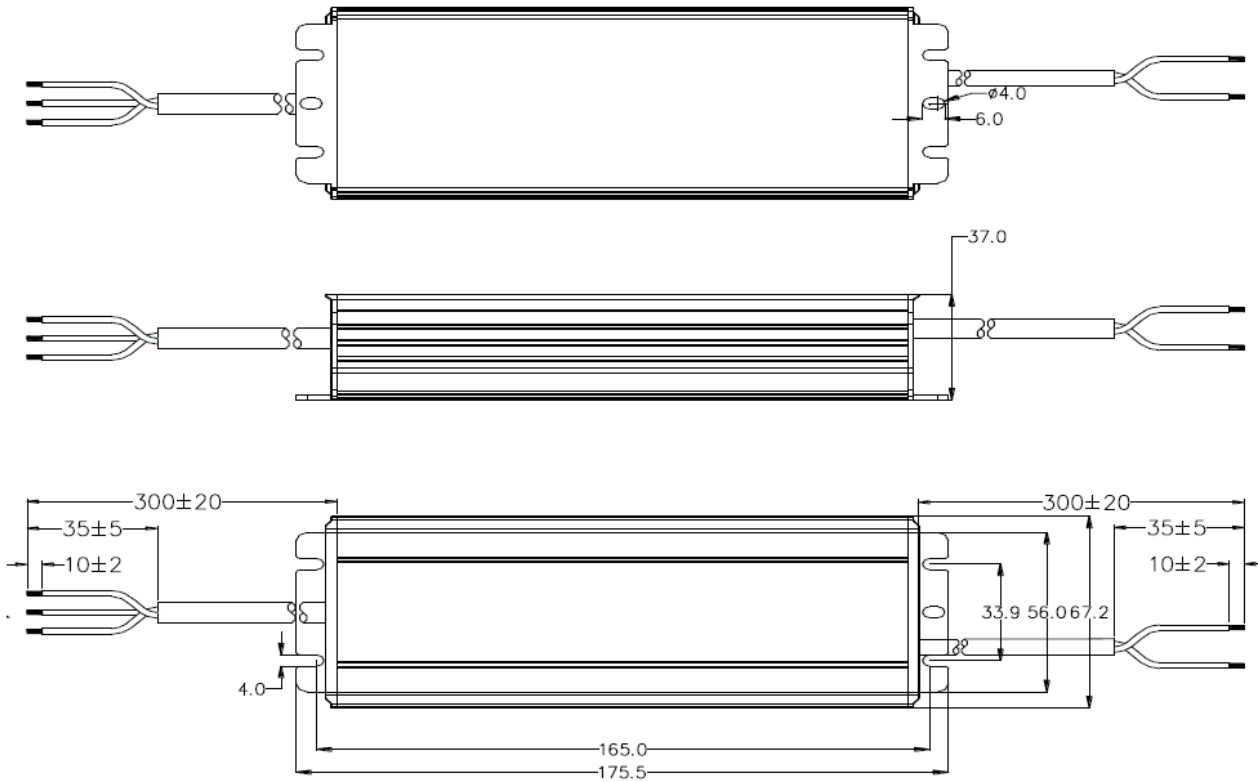

Wire	Specification	Note
INPUT	CCC + VDE, H05RN-F 3x1.0mm <sup>2</sup> , length = 300 ± 20mm	For CCC/CE
	AC/L: brown, AC/N: blue, FG: green/yellow	
OUTPUT	24V: CCC + VDE, H05RN-F 2x1.5mm <sup>2</sup> , length = 300 ± 20mm	For CCC/CE
	36V: CCC + VDE, H05RN-F 2x1.0mm <sup>2</sup> , length = 300 ± 20mm	
	V <sub>0+</sub> : brown, V <sub>0-</sub> : blue	

## CHARACTERISTICS

### INRUSH CURRENT WAVEFORM

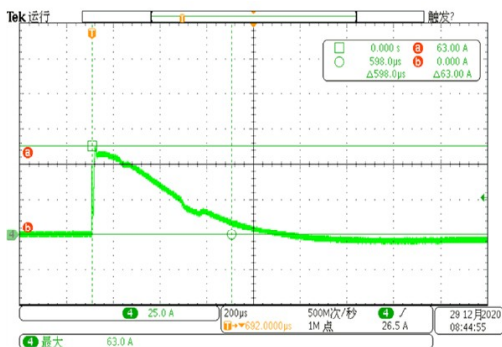

### OUTPUT POWER vs. INPUT VOLTAGE CURVE

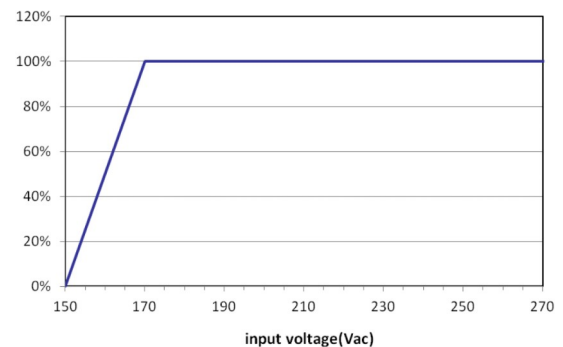

# GV6-240 series

240W Waterproof Constant Voltage LED Driver



## LIFETIME vs. CASE TEMPERATURE CURVE

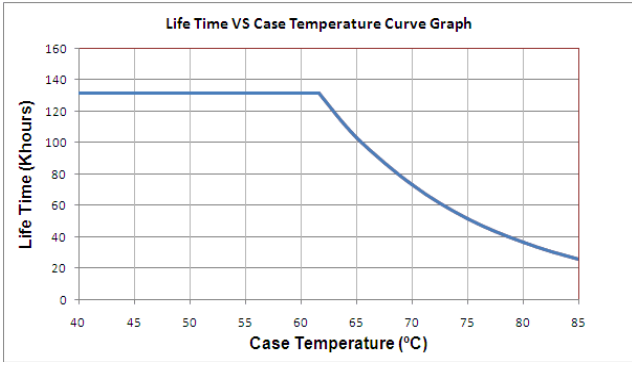

## DERATING CURVE

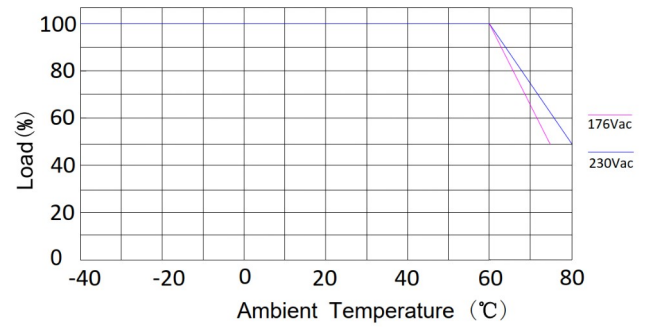

## POWER FACTOR vs. LOAD CURVE

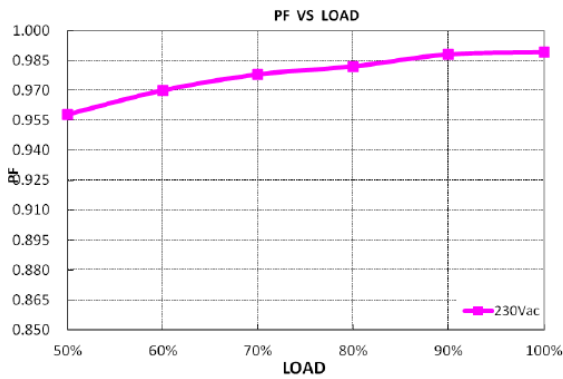

## THD vs. LOAD CURVE

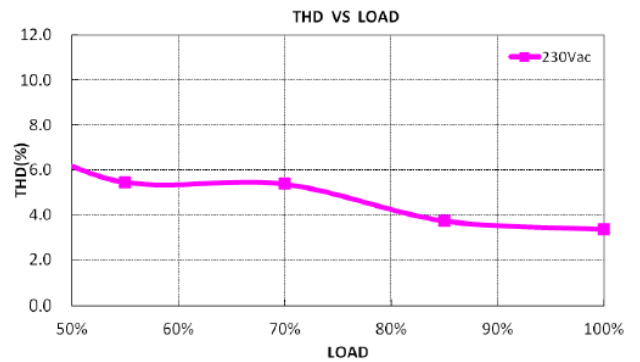

## EFFICIENCY vs. LOAD CURVE

### GV6-240B024

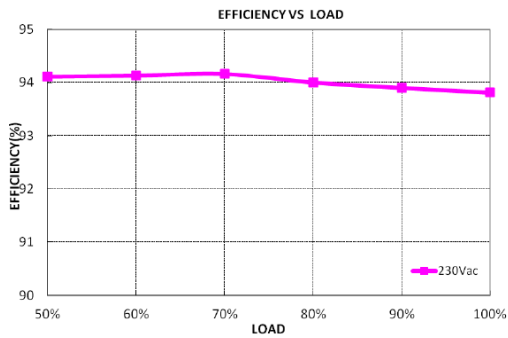

### GV6-240B036

